

EFM1 Gen2 Medium Output Flood Light

The Evolve® LED Medium Output Flood Light is our mid-lumen solution to efficiently illuminate building facade, flag poles, billboard signage and many more traditional flood applications. Designed to replace from 150W - 400W HID flood light solutions.



Construction

Housing:	Aluminum die cast enclosure. Integral heat sink for maximum heat transfer
Lens:	Impact resistant tempered glass
Paint:	Corrosion resistant polyester powder paint, minimum 2.0 mil thickness Standard = Black, Dark Bronze, Gray, White (RAL & custom colors available) Optional = Coastal Finish
Weight:	25 lbs (11.34 kgs)

Optical System

Lumens:	8,500 to 29,000
Distribution:	3x3, 6x5, 6x6, 7x6, 7x7
Efficacy:	116-165 LPW
CCT:	2700K, 3000K, 4000K, 5000K
CRI:	≥70

Electrical

Input Voltage:	120-277V & 277-480V
Input Frequency:	50/60Hz
Power Factor:	≥ 90% at rated watts
Total Harmonic Distortion:	≤ 20% at rated watts

Surge Protection

TYPICAL	ENHANCED	EXTREME
6kV/3kA*	10kV/5kA*	20kV/10kA*

*Per ANSI C136.2-2015

Warranty

5 Year (Standard)

10 Year (Optional)

Lumen Maintenance

Projected Lxx per IES TM-21-11 at 25°C

LUMEN CODES	DISTRIBUTION	LXX(10K) @ HOURS		
		25,000 HR	50,000 HR	60,000 HR
10, 15	77, 76, 67, 66, 65	L99	L99	L99
20, 25	77, 76, 67, 66, 65	L99	L99	L98
30	77, 76, 67, 66, 65	L94	L87	L85
10	33	L97	L97	L97
15, 20	33	L97	L96	L96
25	33	L97	L96	L95

Note: Projected LXX based on LM80 (> 10,000 hour testing). Accepted Industry tolerances apply to initial luminous flux and lumen maintenance measurements.

Luminaire Ambient Temperature Factor

AMBIENT TEMP (°C)	INITIAL FLUX FACTOR	AMBIENT TEMP (°C)	INITIAL FLUX FACTOR
10	1.02	30	0.99
20	1.01	40	0.98
25	1.00	50	0.97

Ratings

Operating Temperature:	-40°C to 50°C*
Vibration^:	3G - Slipfitter Mounting K1, K2, S1 & S2 3G - Trunnion Mounting T1
LM-79:	Testing in accordance with IESNA Standards

*45°C for SKUs >168W at 120-277V with DALI (Option U)

^Per ANSI C136.31-2010

Controls

Dimming:	Standard - 0-10V Optional - DALI (Option U)
Sensors:	Photo Electric Sensors (PE) available LightGrid and Daintree Compatible

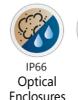

Visit www.designlights.org/search to confirm qualifications.

CUSTOMER NAME _____

PROJECT NAME _____

DATE _____ TYPE _____

CATALOG NUMBER _____

Ordering Information

E F M 1 0 2

7

PROD. ID	GEN	VOLTAGE	OPTIC CODE (lm)	DISTRIBUTION (NEMA HxV)	CRI	CCT	DIMMING	CONTROLS	MOUNTING	COLOR	OPTIONS
E=Evolve	02	0 = 120-277V ¹	10 = 10,000	33 = NEMA 3x3 ³	7 = 70	27 = 2700K	A = ANSI C136.41 7-Pin Receptacle ⁴	A = No Control	K1 = Knuckle slipfitter 1.9 in. - 2.3 in OD Tenon ⁶	GRAY = Gray	F = Fusing ¹
FM= Flood Medium		1 = 120V	15 = 15,000	65 = NEMA 6x5		30 = 3000K	D = No receptacle, with external dimming 18/2 3 ft cable	D = Shorting Cap ⁵	K2 = Knuckle slipfitter 1.9 in. - 2.3 in OD Tenon Supplied with 14/3 3ft power cable	BLCK = Black	H2 = Daintree Enabled motion Sensor ^{7,8}
1= Standard		2 = 208V	20 = 20,000	66 = NEMA 6x6		40 = 4000K	N = No PE Receptacle & Non Dimmable	E = ANSI C136.41 7-pin with non-Dimming PE Control ⁵	S1 = Knuckle slipfitter 2.3-3.0 in. OD Tenon ⁶	DKBZ = Dark Bronze	H4 = Motion Sensor (FSP221) ³
		3 = 240V	25 = 25,000	76 = NEMA 7x6		50 = 5000K	P = ANSI C136.41 7-Pin Receptacle with external dimming 18/2 3 ft cable ⁴		S2 = Knuckle slipfitter 2.3-3.0 in. OD Tenon, Supplied with 14/3 3ft power cable	WHITE = White	L = Tool-Less Entry
		4 = 277V	30 = 30,000 ²	77 = NEMA 7x7					T1 = Trunnion with external 3ft #14/3 power cable		NOM = NOM31 ¹¹
		5 = 480V							V1 = Knuckle Wall Mount ⁶		P06 = Prewired with 6ft #14/3 cable
		D = 347V									R = 10kV/5kA Enhanced Surge Protection Device (SPD)
		E = 277-480V ¹									T = 20kV/10kA Enhanced Surge Protection Device (SPD)
											U = DALI Dimming ⁹
											VO = 3-Position Terminal Block
											V1 = FAM module
											Y = Coastal Finish ¹⁰

NOTES:

- ¹ Fusing requires discrete voltage
- ² Not Available in 3x3 distribution
- ³ Max Lm output = 25K Lm
- ⁴ Restricted aiming angle of 0-45°
- ⁵ Can only be ordered with "A" or "P" Dimming Options
- ⁶ Supplied with leads
- ⁷ Not available in 347V, 480V OR 277-480V
- ⁸ Only available in K1 or S1 mount
- ⁹ Compatible with LightGrid System
- ¹⁰ Recommended for installations within 750 feet from coast. Lead time varies, check with factory
- ¹¹ Contact Manufacturer

CUSTOMER NAME _____

PROJECT NAME _____

DATE _____ TYPE _____

CATALOG NUMBER _____

LUMEN OUTPUT	DIST CODE	CLASSIFICATION (HxV)	TYPICAL INITIAL LUMENS				SYSTEM WATTAGE
			2700K	3000K	4000K	5000K	
10	77	7x7	9900	10600	11000	11000	67
15			13500	14550	15000	15000	91
20			18000	19400	20000	20000	124
25			22500	24250	25000	25000	162
30			26100	28130	29000	29000	195
10	76	7x6	9900	10600	11000	11000	67
15			13500	14500	15000	15000	91
20			18000	19400	20000	20000	124
25			22500	24200	25000	25000	162
30			26100	28100	29000	29000	195
10	66	6x6	9900	10600	11000	11000	67
15			13500	14500	15000	15000	91
20			18000	19400	20000	20000	124
25			22500	24200	25000	25000	162
30			26100	28100	29000	29000	195
10	65	6x5	8500	9200	9500	9500	67
15			11700	12600	13000	13000	91
20			15600	16800	17400	17400	124
25			19500	21000	21700	21700	162
30			22600	24400	25200	25200	195
10	33	3x3	10300	10600	11100	11100	78
15			13900	14400	15000	15000	105
20			18600	19200	20000	20000	144
25			23200	24000	25000	25000	186

For additional information on Shielded and Non-Shielded EFM IES files, please refer to LED.com

EFM1
NEMA 7x7

29,000 Lumens
4000K
EFM102_3077740_IES

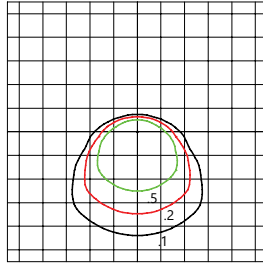

- Mounting Height at 35°
- 45° Tilt Initial Footcandle at Grade

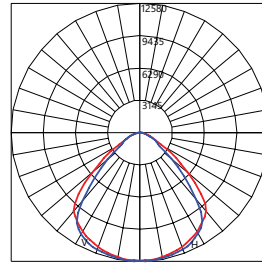

- Vertical Axial Candela Distribution
- Horizontal Axial Candela Distribution

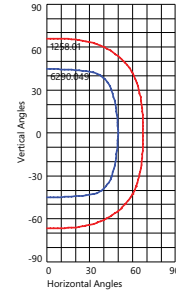

EFM1
NEMA 7x6

29,000 Lumens
4000K
EFM102_3076740_IES

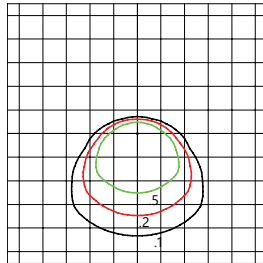

- Mounting Height at 35°
- 45° Tilt Initial Footcandle at Grade

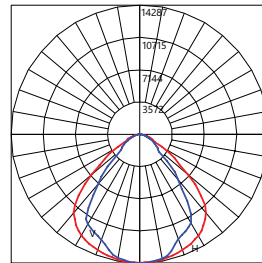

- Vertical Axial Candela Distribution
- Horizontal Axial Candela Distribution

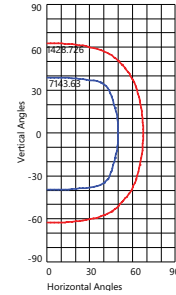

EFM1
NEMA 6x6

29,000 Lumens
4000K
EFM102_3066740_IES

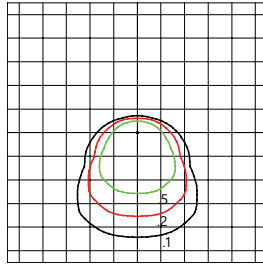

- Mounting Height at 35°
- 45° Tilt Initial Footcandle at Grade

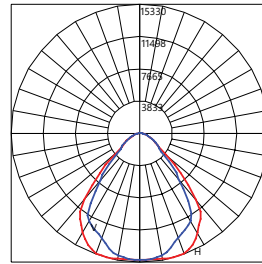

- Vertical Axial Candela Distribution
- Horizontal Axial Candela Distribution

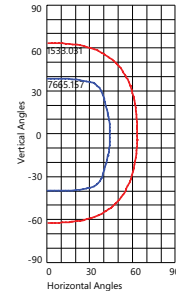

EFM1
NEMA 6x5

25,200 Lumens
4000K
EFM102_3065740_IES

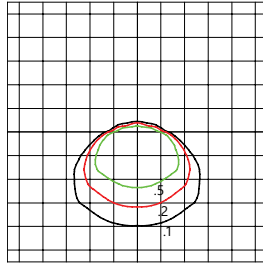

- Mounting Height at 35°
- 45° Tilt Initial Footcandle at Grade

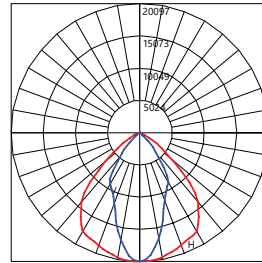

- Vertical Axial Candela Distribution
- Horizontal Axial Candela Distribution

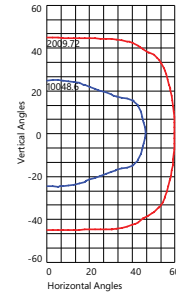

EFM1
NEMA 3x3

25,000 Lumens
4000K
EFM102_2533740_IES

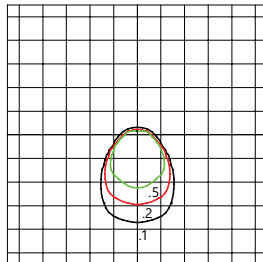

- Mounting Height at 35°
- 45° Tilt Initial Footcandle at Grade

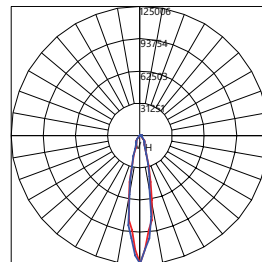

- Vertical Axial Candela Distribution
- Horizontal Axial Candela Distribution

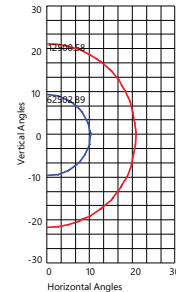

EFM1 Gen2

Medium Output Flood Light

CUSTOMER NAME _____

PROJECT NAME _____

DATE _____ TYPE _____

CATALOG NUMBER _____

H4 Motion Sensing Option

Recommended Mounting Height:	15-30' (4.6-9.1m)
Coverage Radius:	15-20' (4.6-6.1 m)
Lateral Coverage:	300 °
Power:	Adds < 1W to fixture power rating
Total Harmonic Distortion:	≤ 20% at rated watts
Default Settings:	
Output:	Occupied - 100% Unoccupied - 10%
PE Sensor:	None
Ramp/Fade:	Disabled
Time (Off) Delay:	5 min.
Field:	Programmable using FSIR-100 hand held programmer (197634)

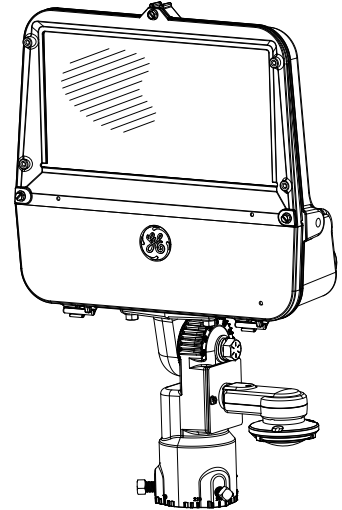
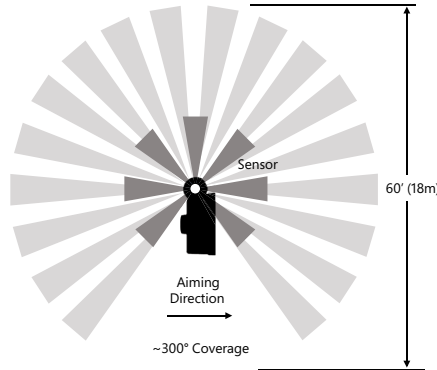

H2 - Daintree Enabled Motion Sensing Option

Recommended Mounting Height:	15-30' (4.6-9.1m)
Coverage Radius:	15-20' (4.6-6.1 m)
Lateral Coverage:	300 °
Power:	Adds < 1W to fixture power rating
Total Harmonic Distortion:	≤ 20% at rated watts
Default Settings:	
Output:	Occupied - 100% Unoccupied - 10%
PE Sensor:	None
Ramp/Fade:	Disabled
Time (Off) Delay:	10 min.
Requires Wireless Area Controller (WAC)	

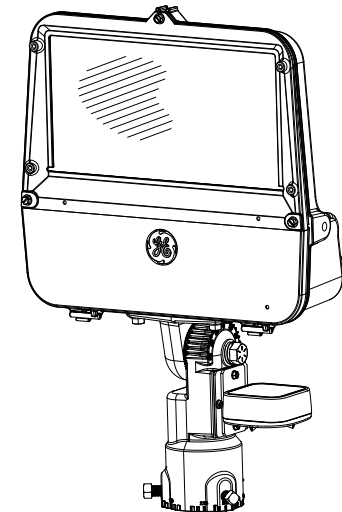
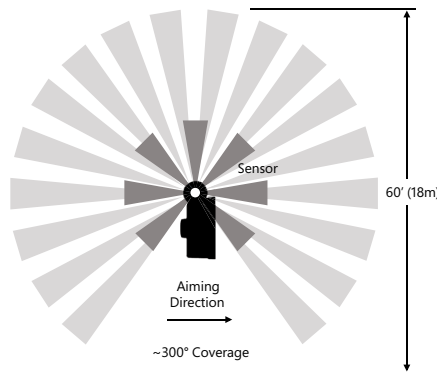

CUSTOMER NAME _____

PROJECT NAME _____

DATE _____ TYPE _____

CATALOG NUMBER _____

Mounting

Option K

- K1=Knuckle Slipfitter for 2.3 in. OD Tenon. Lead wires exiting tenon.
- K2=Knuckle Slipfitter for 2.3 in. OD Tenon, ext. 3ft #14/3 cord.

Option S

- S1=Knuckle Slipfitter for 2.3 in-3.0 in. OD Tenon. Lead wires exiting tenon.
- S2=Knuckle Slipfitter for 2.3 in-3.0 in. OD Tenon, ext. 3ft #14/3 cord.

Option V

- V1=Knuckle Wall Mount. Lead wires exiting tenon.

Option T

- T1=Trunnion, with external 3ft #14/3 cord.

Accessories

SAP NUMBER	PART NUMBER	DESCRIPTION
93123552	WANSI - 277	ANSI C136.41 Dimming PE Daintree Enable, 105-305V
93123553	WANSI - 480	ANSI C136.41 Dimming PE Daintree Enable, 312-530V
93029237	PED-MV-LED-7	ANSI C136.41 Dimming PE, 120-277V
93029238	PED-347-LED-7	ANSI C136.41 Dimming PE, 347V
93029239	PED-480-LED-7	ANSI C136.41 Dimming PE, 480V
28299	PEC0TL	Standard 120-277V
28294	PEC5TL	Standard 480V
80436	PECDTL	Standard 347V
73251	SCCL-PECTL	Shorting Cap

Effective projected area

- 0° aim (vertical glass) 1.96 sq. ft.
- 45° aim 1.22 sq. ft.
- Side profile (all aims) 0.73 sq. ft.
- 90° (downward) aim 0.79 sq. ft.

SHIELDS

SAP NUMBER	PART NUMBER	DESCRIPTION	COLOR
93081902	TSVBLOCK-EFM	Top and Side Visor	Black
93081903	TSVDKBZ-EFM	Top and Side Visor	Dark Bronze
93081901	TSVGRAY-EFM	Top and Side Visor	Gray
93081904	TSVWHITE-EFM	Top and Side Visor	White
93080086	VAN-EFM	Vandal Shield	
93080087	WG-EFM	Wire Guard	
93079843	BDABLOCK-EFM	Barn Doors	Black
93079844	BDADKBZ-EFM	Barn Doors	Dark Bronze
93079842	BDAGRAY-EFM	Barn Doors	Gray
93079845	BDAWHITE-EFM	Barn Doors	White

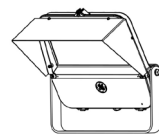

TSV
Top & Side Visor



VAN
Vandal Shield



WG
Wire Guard

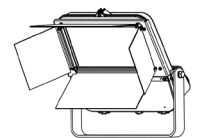

BDA
Barn Doors